

SECTION CORNER RECORD

NW 500-000

BOONE COUNTY SURVEYOR'S OFFICE

State Plane grid coordinates NAD83 (CORS96):

Corner 1: North: 1772009.54 East: 3124823.06 (U.S. survey feet)

Corner 2: North: 1772102.14 East: 3124822.80 (U.S. survey feet)

Type of monument: Harrison, 4" disk 'Section Corner'

Depth: flush to 2 inches above adjacent ground.

Indiana tie card references:

IN02_T19NR1E06_72 IN02_T19NR1E07_00
IN02_T19NR1W01_80 IN02_T19NR1W12_08

- A - Nail in S. edge wood end post, 1' a.g., 103.93' to corner 1, 11.33' to corner 2
- B - Boone County witness mark, flush, 92.68' to corner 1, 29.56' to corner 2
- C - Mag nail set in W. side power pole, 1' a.g., 13.95' to corner 1, 78.98' to corner 2
- D - Boone County witness mark, flush, 33.54' to corner 1, 102.24' to corner 2

Boone County witness mark is a 3/8" diameter x 2' long rebar bearing a metal cap stamped "Boone County Witness Point."

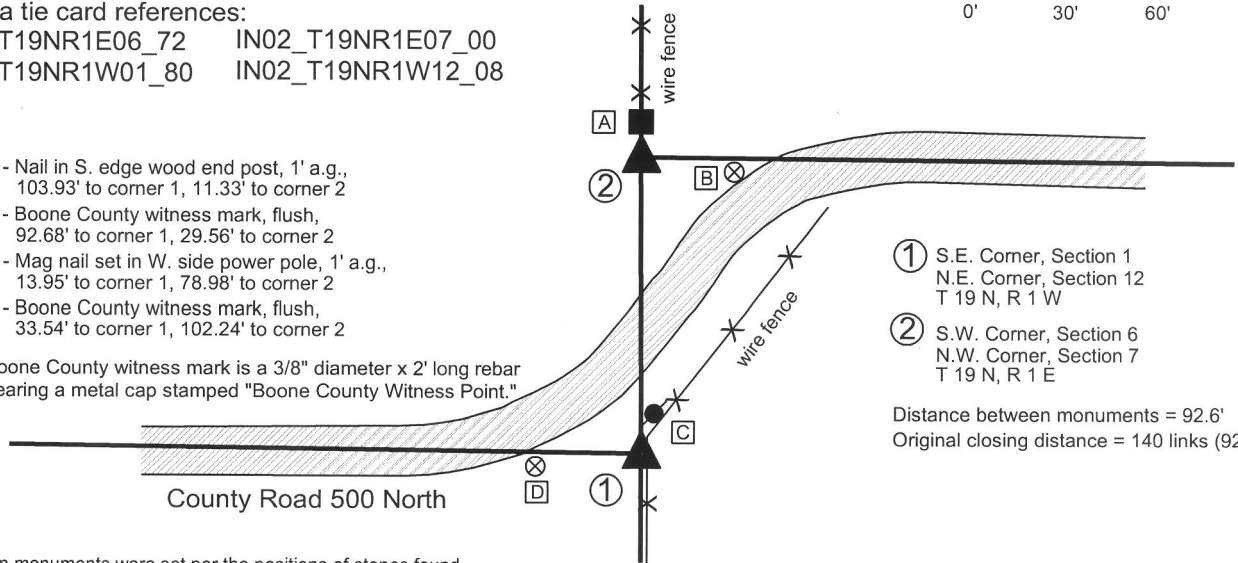

- ① S.E. Corner, Section 1
N.E. Corner, Section 12
T 19 N, R 1 W
- ② S.W. Corner, Section 6
N.W. Corner, Section 7
T 19 N, R 1 E

Distance between monuments = 92.6'
Original closing distance = 140 links (92.4')

The harrison monuments were set per the positions of stones found.

A BCS record of May 9, 1872 pertaining to the southwest corner of section 6, T19N, R1E (corner 2) states "Reestablished from Elm and Stump of Burr Oak. Elm is 67 links dist. Set Rock 14.8.5 1/2 marked +." A BCS record of April 19, 1895 pertaining to the southeast corner of section 1, T19N, R1W (corner 1) states "Set rock 24x15x5 established from lap." It is noted that the term "lap" refers to the offset distance between the standard and closing corners on the range line. At this corner the "lap" recorded in the original notes is 140 links, or 92.4 feet.

BCS tie cards dated October 14, 1971 pertaining to each of the corners state that a stone was found at corner 1 and that no stone was found and a RRR (railroad rail) was "put in" at corner 2. The tie cards show the two corners to be 97 feet apart. A BCS tie card dated January 18, 1994 pertaining to corner 1 shows the corner as being a 1/2 inch rebar. This card shows corner 1 to be 108 feet south of a corner post to the north. As the rail called for in the 1971 tie card was found at 11 feet south of this post and the stone called for in 1971 tie card was shown to be 97 feet south of the rail, it is evident that the 1/2 inch rebar called for in 1994 was in the position of the stone called for in 1971. A pair of BCS tie cards dated September 20, 2005 show corner 1 as a harrison monument and corner 2 as a railroad rail, with the two monuments at 92.39 feet apart.

Excavation in the fall of 2013, concluding on October 29, 2013 revealed both of the record stones described in the 1872 and 1895 records. The stone at corner 1 was found at 4 inches deep, slightly southwest of the harrison monument shown on the 2005 record. This stone measures 24 inches tall by 15 inches N-S by 5 inches E-W. The rebar shown on the 1994 tie card was found 4.6 feet south and 1.4 feet west of the stone. The stone at corner 2 was found 0.8 feet south and 0.8 feet east of the railroad rail shown on the 1971 and 2005 tie cards. This stone was found at 6 inches deep and measured 14 inches tall by 8 inches E-W by 5 1/2 inches N-S. The distance measured from the high point to the high point of the respective stones was 92.6 feet, barely longer than the record call of 140 links (92.4 feet). The harrison monument and railroad were both removed. The stone at corner 2 was also removed and replaced with a harrison monument set at the position of the high point of the stone. The stone at corner 1 was left in place. The specific position of corner 1 was determined at 92.6 feet along the prolongation of the range line from the standard corner 1/2 mile north through the stone at corner 2. This point fell slightly east of the high point of the stone. A 15 inch diameter section of HDPE storm pipe was notched and set vertically over and amongst the stone. The stone was encased in concrete and the harrison monument was set at the calculated point slightly east of the high point of the stone. It is noted that typically the closing corner is shifted to fit to the range line, per the procedures of the original federal surveyors. However, in this case it is clear the stone at corner 2 was established first per the bearing trees and that the stone at corner 1 was established relative to corner 2. Hence, in this particular case, corner 2 was held as the dominant corner for purposes of establishing the range line, though given that corner 1 was established along the prolongation of the line from the north through corner 2, the bend in the range line occurs at corner 1, as is typical. Corner 2 falls on the range line with no bend at that point.

No stone was found near the 1/2 inch rebar called for in the 1994 tie card. An adjoining land owner stated that a large rock had been visible above ground at that point but was removed many years ago.

Corner 1 was established in October, 1819 and corner 2 was originally established in June, 1822.

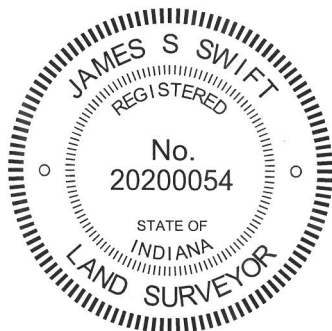

Kenneth E. Hedge
Kenneth E. Hedge, County Surveyor

James S. Swift
James S. Swift, IN LS 20200054
February 5, 2015

Washington Township	Clinton Township
Section 1 T19N, R1W	Section 6 T19N, R1E
Section 12 T19N, R1W	Section 7 T19N, R1E

PHOTOGRAPHIC DOCUMENTATION

Date of photography: October 22-29, 2013

View from above showing the stone at the closing corner and the railroad rail.



The closing corner and the fence to the north.



View from above the stone at the closing corner, looking east along C.R. 500 North.



The stone at the standard corner, and the harrison monument found. See documentation.



The stone at the standard corner. View from above and west.



For details and documentation, refer to related sheet "Section Corner Record."

SECTION CORNER RECORD

NW 500-100

BOONE COUNTY SURVEYOR'S OFFICE

State Plane grid coordinates NAD83 (CORS96):
North: 1772071.05 East: 3119444.88 (U.S. survey feet)

Type of monument: Harrison, 4" disk 'Section Corner'
Depth: six inches below adjacent gravel road surface

Indiana tie card references:
IN02_T19NR1W02_80 IN02_T19NR1W01_72
IN02_T19NR1W11_08 IN02_T19NR1W12_00

CORNER WITNESS DETAIL

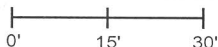
SCALE 1" = 30' 

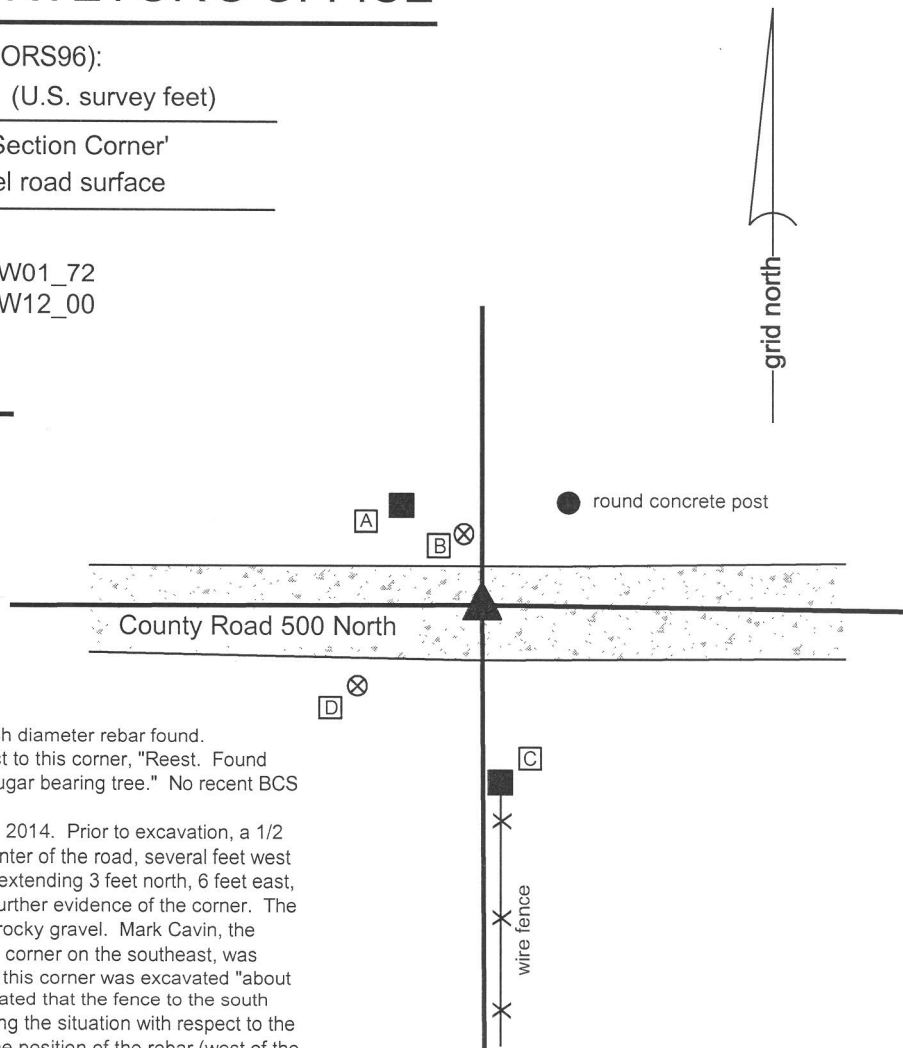

The Harrison monument was set in place of a 1/2 inch diameter rebar found. A BCS record of March 5-7, 1863 states, with respect to this corner, "Reest. Found stone at corner and marked it. Found roots of one sugar bearing tree." No recent BCS tie cards were found referencing this corner. Excavation was performed at this corner on June 30, 2014. Prior to excavation, a 1/2 inch diameter rebar was found in the approximate center of the road, several feet west of the old fence to the south. Excavation of an area extending 3 feet north, 6 feet east, 5 feet south and 3 feet west of the rebar yielded no further evidence of the corner. The road bed in this vicinity was 4 to 6 inches of a large, rocky gravel. Mark Cavin, the resident and owner of the property which adjoins this corner on the southeast, was present during the excavation. Mr. Cavin stated that this corner was excavated "about 30 years ago and they found something." He also stated that the fence to the south had been there as long he could remember. Analyzing the situation with respect to the type of monument found (1/2 inch diameter rebar), the position of the rebar (west of the fence) and the time frame of previous excavation per Mr. Cavin's testimony, it is reasonable to conclude that the stone may have been found at that time and replaced with the 1/2 inch rebar. It is known that it was common practice for field crews in that era to remove stones, if found, and replace them with metal monuments, but not necessarily fully document the activity. Many stones are known to have been replaced with 1/2 inch rebars. The fact that the rebar is not in line with the fence is taken as evidence in support of this. It is common for stones to be found a short distance one side or the other of a fence, but it is typical that metal monuments set at estimated positions without the benefit of older evidence, such as a stone, to be set more in line with the fence. It is further noted that the rebar also fit very well with deed distances relative to monumentation and evidence of occupation for property corners to the east. The rebar was accepted as the best available evidence of the corner. The rebar was removed and replaced with a Harrison monument in the same position. This corner was originally established as a wood post in 1822.

- A - Mag nail set in S.E. side wood post, 2' a.g., 19.2'
- B - Boone County witness mark, flush, 11.5'
- C - Mag nail set in N. side wood post, 2' a.g., 26.2'
- D - Boone County witness mark, flush, 23.2'

Boone County witness mark is a 3/8" diameter x 2' long rebar bearing a metal cap stamped "Boone County Witness Point."

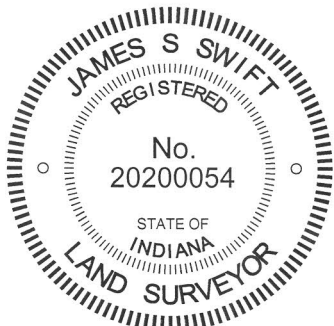

Kenneth E. Hedge, County Surveyor

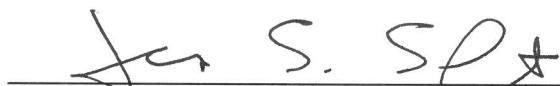
James S. Swift, IN LS 20200054
March 27, 2015

Washington Township

Section 2 T19N, R1W	Section 1 T19N, R1W
Section 11 T19N, R1W	Section 12 T19N, R1W

SECTION CORNER RECORD

BOONE COUNTY SURVEYOR'S OFFICE

NW 550-000

State Plane grid coordinates NAD83 (CORS96):

North: 1774643.20 East: 3124815.16 (U.S. survey feet)

Corner 1 only

Type of monument: Harrison, 4" disk 'Section Corner'

Depth: Four inches above adjacent ground

Indiana tie card references:

IN02_T19NR1E06_36

IN02_T19NR1W01_44

CORNER WITNESS DETAIL

SCALE 1" = 30'

A - East edge of 12 in. diameter walnut tree at 2' a.g., 33.6'

B - Mag nail set in W. side, wood line post, 2' a.g., 16.5'

The harrison monument was set in place of the base of a wood corner post. A BCS record of October 25, 1878 states, with respect to corner 1 "Reest. from trees, the sugar is dead & only stp of ash. Set a rock 10.7.5 marked +. Thence N. 140 links Est quar sect. on west of section 6, Set a rock 10.8.6 +." A record pertaining just to corner 2 states that the 10.8.6 + rock was set 140 links N. of the standard corner, but this record is dated October 25, 1876. No explanation is offered for the two year discrepancy in the records. This corner was excavation on October 23, 2013. Prior to excavation, a wood corner post was found with existing, though ancient, fence to the south and west with fencing apparently cut off towards the east. Manual excavation in the vicinity of the post yielded several small rocks found but none appeared to be the stone described in the 1878 record. The found rocks also did not appear to be intended to act as corner marker stones. Corner 2 falls in a tilled field. Extensive probing was performed in the vicinity of corner 2, as determined at 140 links N of corner 1. No further evidence was found in the vicinity of corner 2. The corner post was accepted as providing the best evidence of corner 1. The post was rotten at the base and the above ground portion of the post appeared to be yet standing due to being supported by wire from the adjacent fence. The fencing was cut-away and the post was broken off at ground level. The top portion of the post was pushed away to the west. The in-ground portion the post was chopped out of the ground and a harrison monument was set in place of the post. The specific location of corner 2 has not yet been determined as of the publication of this document. Corner 1 was originally established as a wood post in 1819. Corner 2 was not set by the original federal surveyors.

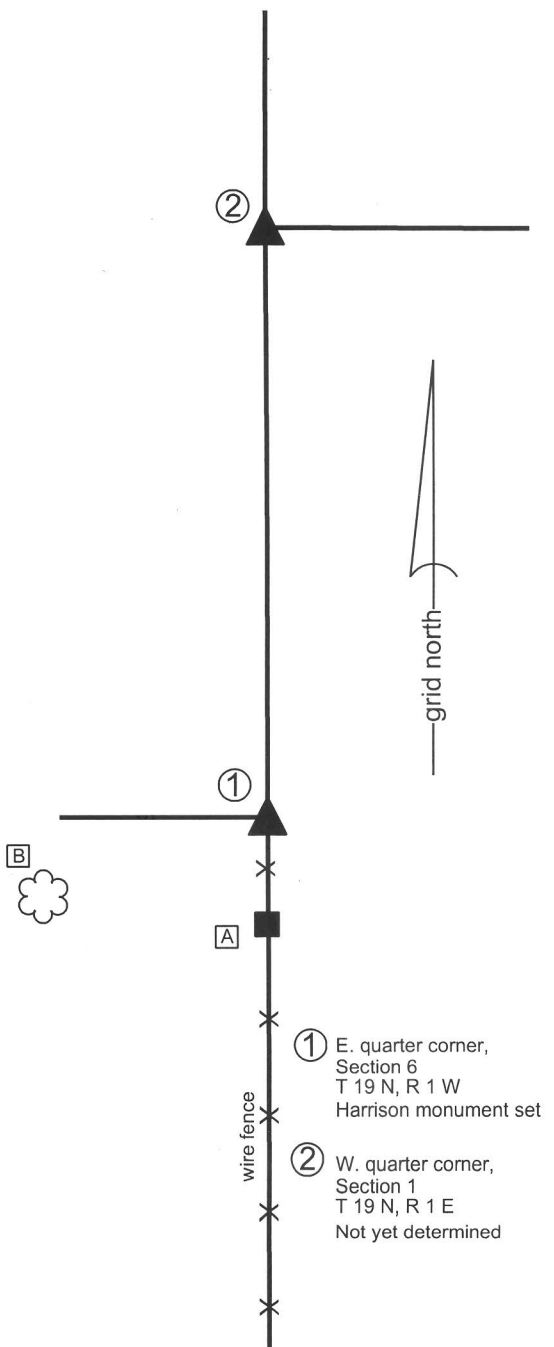

- ① E. quarter corner, Section 6
T 19 N, R 1 W
Harrison monument set
- ② W. quarter corner, Section 1
T 19 N, R 1 E
Not yet determined

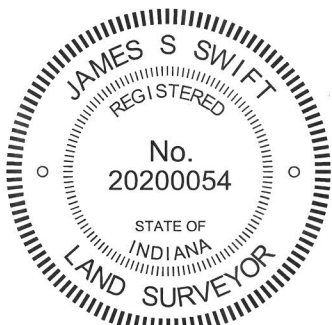

Kenneth E. Hedge
Kenneth E. Hedge, County Surveyor

James S. Swift
James S. Swift, IN LS 20200054
February 5, 2015

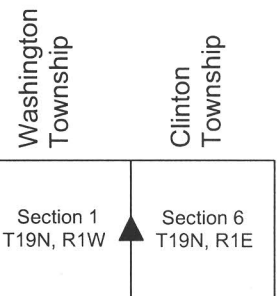

SECTION CORNER RECORD

NW 600-000

BOONE COUNTY SURVEYOR'S OFFICE

State Plane grid coordinates NAD83 (2011):

North: 1777284.21 East: 3124807.27 (U.S. survey feet)

Type of monument: INDOT Type B, plug in monument box

Depth: Flush with adjacent road surface

Indiana tie card references:

IN02_T20NR1E31_72 IN02_T20NR1W36_80

IN02_T19NR1W01_08 IN02_T19NR1E06_00

CORNER WITNESS DETAIL

SCALE 1" = 50'

- A - Boone County witness mark, flush, 43.2'
- B - Mag nail set in N. side power pole, 3.5' a.g., 110.9'
- C - Mag nail set in N.W. side wood corner post, 3' a.g., 55.1'
- B - Mag nail set in N.E. side power pole, 3.5' a.g., 116.5'
- E - Mag nail set in top of wooden guard rail post, 24.7'
- F - Disk Benchmark in top of wing wall, bridge, 33.7'

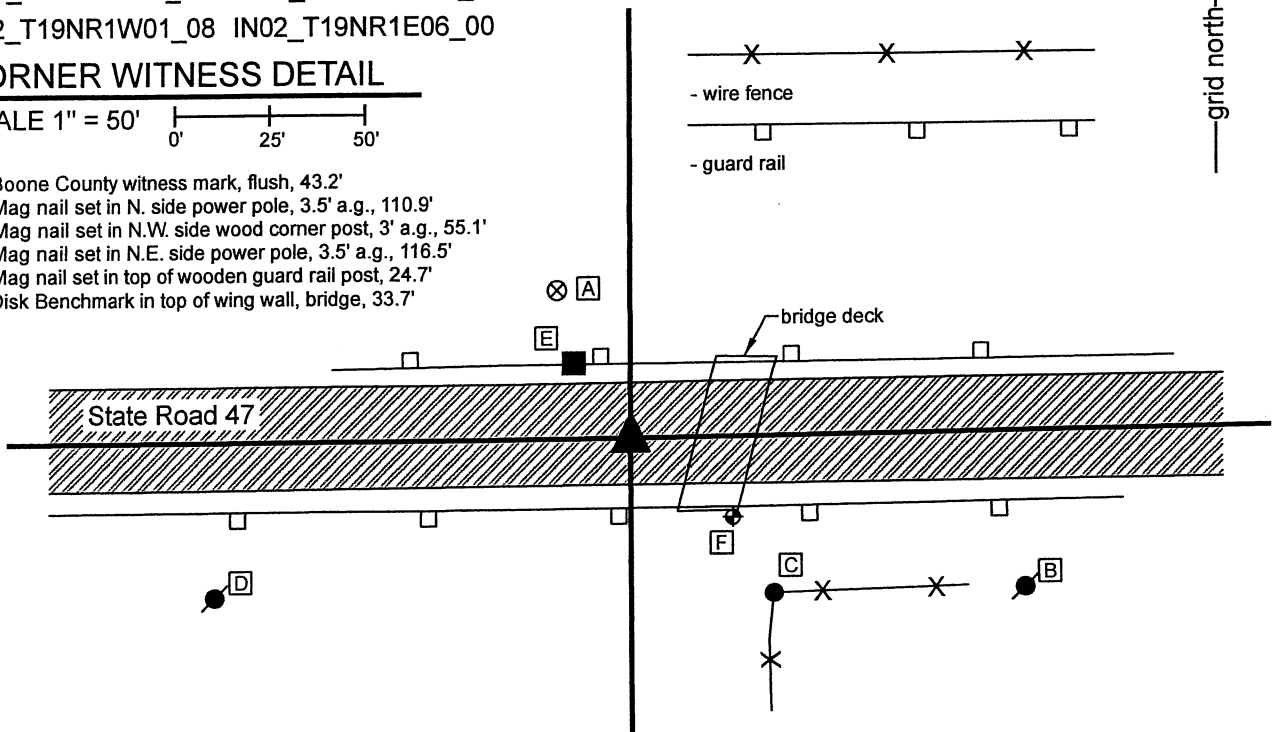

The INDOT Type B monument was found in place.

A BCS record of November 10, 1887 shown in the records of Section 36, Township 20 North, Range 1 West states, with respect to this corner, "Drove stake in road at corner, 36 1/2 links north of corner."

A BCS tie card dated 2004 shows the corner as a P.K. Nail with washers. A subsequent BCS tie card, dated June 22, 2005, shows the corner as a Type "C" Monument in the same position as the nail shown on the previous tie card.

The monument found, being an INDOT Type 'B' monument, appears to be the same monument, in the same position, as those shown on the 2005 tie cards. This corner falls amidst an area of fill immediately west of a bridge under State Road 47. The only local evidence of the corner is the east-west state road. The position of the corner fits well with the relative positions of proximate corners to the east and west.

No excavation was performed at this corner, as it falls in a state highway and is an area of fill. The existing monument is held as the best available evidence of the respective corner. This township corner was originally established as a wood post in 1819.

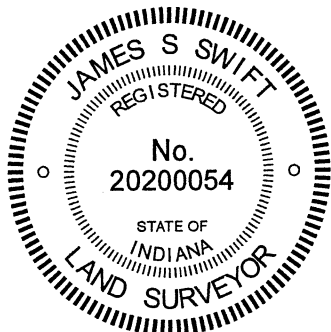

Kenneth E. Hedge
Kenneth E. Hedge, County Surveyor

James S. Swift
James S. Swift, IN LS 20200054
January 26, 2021

Washington Township	Clinton Township
Section 36 T20N, R1W	Section 31 T20N, R1E
Section 1 T19N, R1W	Section 6 T19N, R1E

SECTION CORNER RECORD

NW 600-100

BOONE COUNTY SURVEYOR'S OFFICE

State Plane grid coordinates NAD83 (2011):

Corner 1: North: 1777272.78 East: 3119542.02 (U.S. survey feet)

Corner 2: North: 1777272.76 East: 3119487.85 (U.S. survey feet)

Type of monument: INDOT Type B, plug in monument box

Depth: flush with adjacent road surface

Indiana tie card references:

IN02_T20NR1W35_80 IN02_T20NR1W36_72

IN02_T19NR1W05_08 IN02_T19NR1W06_00

CORNER WITNESS DETAIL

SCALE 1" = 40'

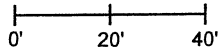

- A - Boone County witness mark, flush, 72.1' to Corner 1, 26.3' to Corner 2
- B - Boone County witness mark, flush, 34.6' to Corner 1, 77.9' to Corner 2
- C - Mag nail set in N. side power pole, 2' a.g., 55.3' to Corner 1, 101.6' to Corner 2
- D - Mag nail set in S. side power pole, 3' a.g., 44.5' to Corner 1, 48.3' to Corner 2
- E - Top, center of wood corner post 40.5' to Corner 1, 67.6' to Corner 2

- ① S.E. Corner, Section 35
S.W. Corner, Section 36
T 20 N, R 1 W
- ② N.E. Corner, Section 2
N.W. Corner, Section 1
T 19 N, R 1 W

Distance between monuments: 54.17'
Original federal closing distance: 82 links = 54.1'

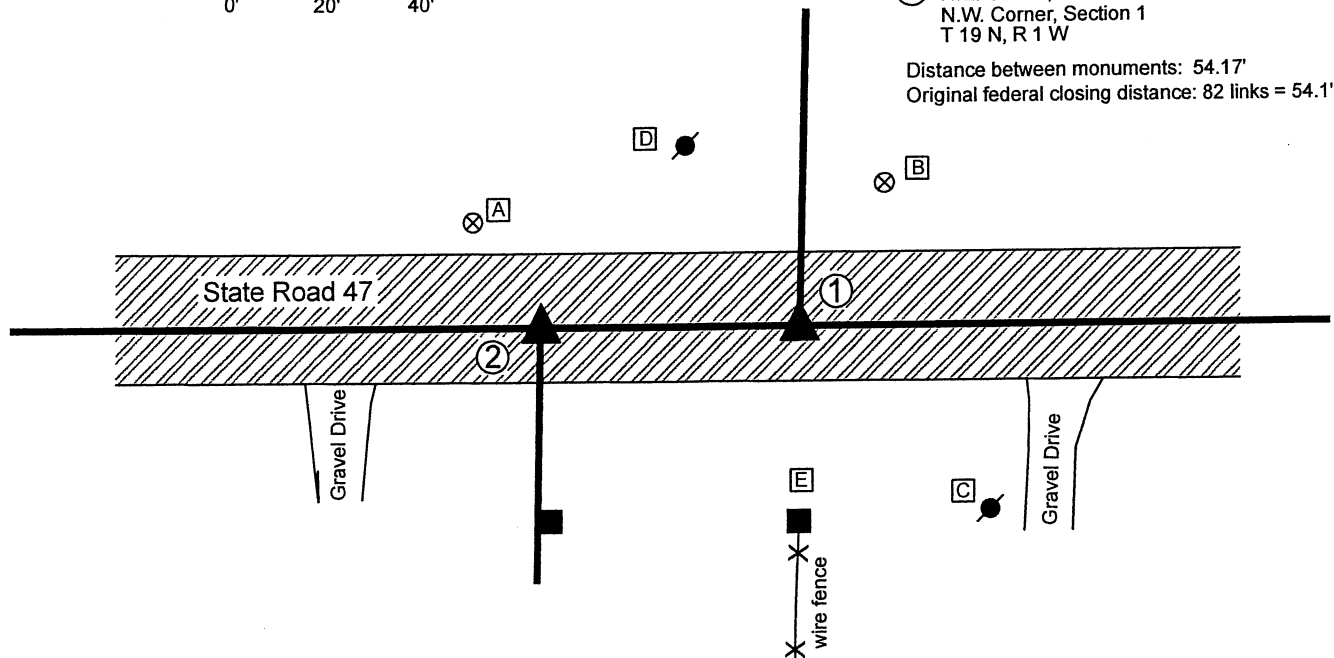

The INDOT Type B monuments were found in place. A BCS record of February 16, 1855 states, with respect to Corner 1, "Relocated. Set Stone. No Tree." Another BCS record of the same date states, with respect to Corner 2, "Stone marked S1,2." A BCS tie card dated June 22, 2005 shows both corners as P.K. Nails with washers. A Surveyor's Report for INDOT, recorded as Instrument 200700000086 in the Office of the Boone County Recorder, shows both corners as INDOT Type B Monuments and states that the monument at Corner 1 was set in place of a P.K. Nail with washer and Corner 2 was set in place of a Mag Nail, with references to INDOT plat RS-28322 (SR47). The monuments found appear to be the same monuments, in the same positions, as those shown on the 2007 INDOT report. The separation of the monuments is within 0.1 of a foot of the federal closing distance reported for Corner 2 in 1822. The positions of the corners fit reasonably well with the relative positions of proximate corners to the east and west. No excavation was performed at these corners, as they fall in a state highway. The existing monuments are held as the best available evidence of the respective corners. Corner 1 was originally set as a wood post in 1819. Corner 2 is not an original federal corner.

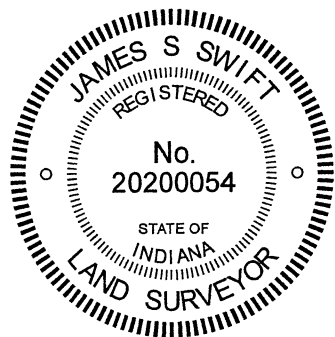

Kenneth E. Hedge
Kenneth E. Hedge, County Surveyor

James S. Swift
James S. Swift, IN LS 20200054
January 26, 2021

Washington Township

